

UNIVERSITY OF WATERLOO

UW ASIC GROUP: Cadence Tutorial

Description:

Part I: logging into UNIX and opening Cadence.

Part II: simulation of a CMOS inverter.

PART I: LOGGING INTO UNIX AND OPENING CADENCE

LOGGING INTO UNIX:

1. UNIX workstations are located in E2 3364, 3366, and 3368.
NB: Email the leader of the Analog Group to obtain the 5-digit code used to access these rooms.
2. Use your SunEE account to log into a UNIX workstation:
user name: your engmail user name
password: your UW student ID number.

OPENING CADENCE:

1. Cadence must be opened from the folder in which you store your Cadence files. **Never run Cadence from the root directory.** First, open a terminal window:
 - (a) Right click on the desktop,
 - (b) Select Tools,
 - (c) Select Terminal.



2. SSH into the uwasic account:
`ssh -l uwasic blade1.vlsi`
password: (the password will be provide to you in the tutorial).
3. Enter the *cadence* folder:
`cd cadence`

Create a *tutorialsX* folder (The value of X will be assigned to you in the tutorial.):

```
mkdir tutorialsX
```

```
cd tutorialsX
```

4. You are now in the folder where your Cadence files will be store, and may open Cadence:
`startCds -t cmosp18`

This opens **icfb Command Interpreter Window (CIW)** . A window titled “What’s New in 4.4.6” may also open – you may close this.

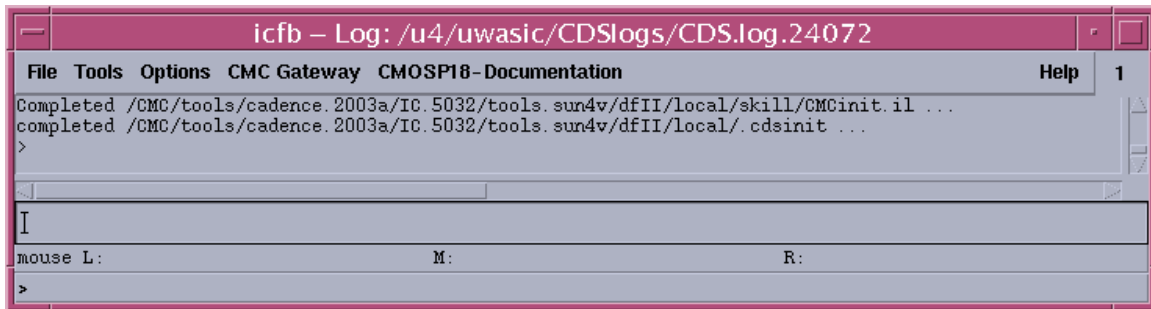

PART II: SIMULATION OF A CMOS INVERTER

Virtuoso® and **Analog Design Environment** are the two Cadence CAD tools that we will use.

Virtuoso® is used for schematic capture. **Analog Design Environment** uses the **Spectre** simulation engine to simulate the schematic.

1. In CIW (**icfb**, shown above) open the **Library Manager: Tools > Library Manager**.

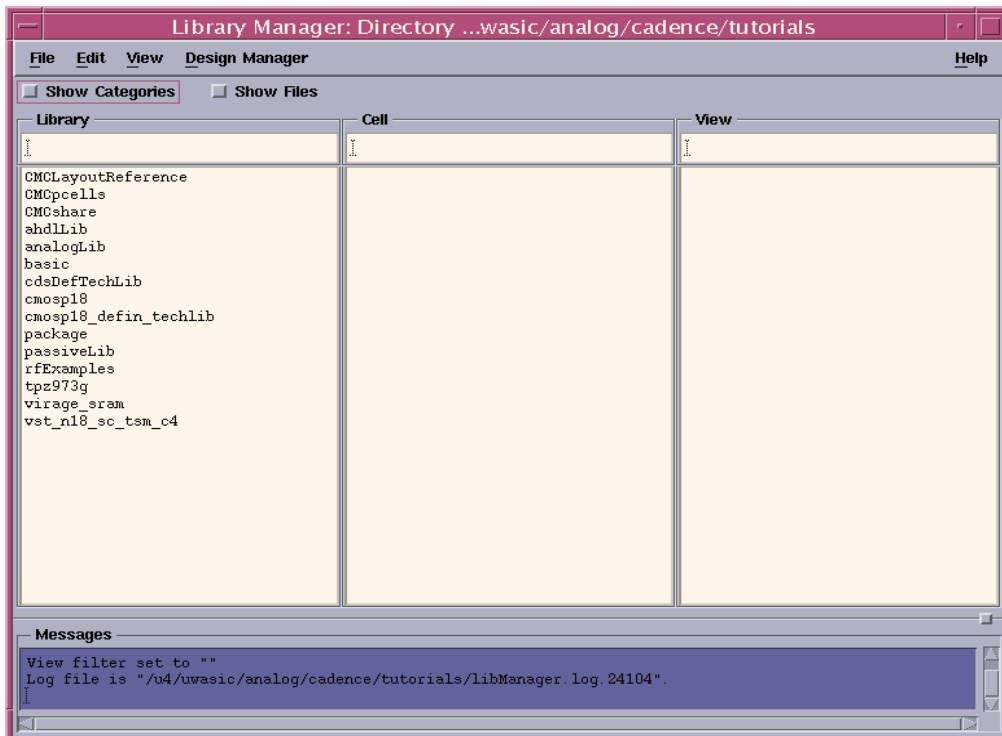

2. In **Library Manager** create a new library: **File >New > Library**.

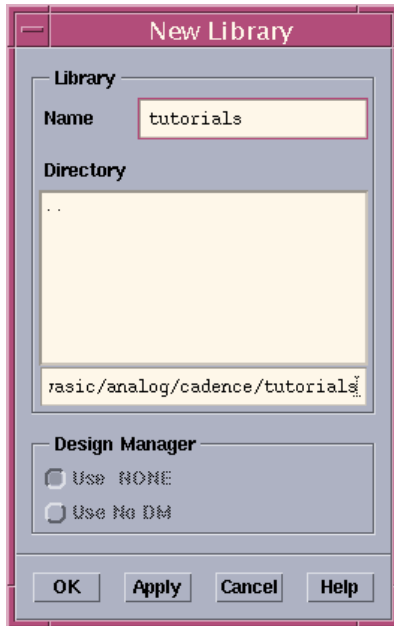

- (a) Enter the Library Name: *tutorials*.
(b) Click OK.

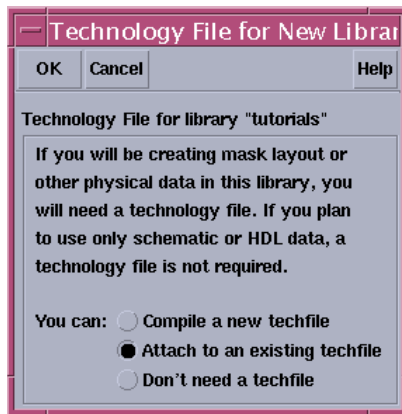

- (c) Select **Attach to existing techfile**.
(d) Click OK.



- (e) Choose **cmosp18** from the Technology Library dropdown list.
(f) Click OK.

The *tutorials* library now appears in the Library Manager window.

SCHEMATIC CAPTURE

1. In Library Manager select the *tutorials* library, then: **File > New > Cell View**.

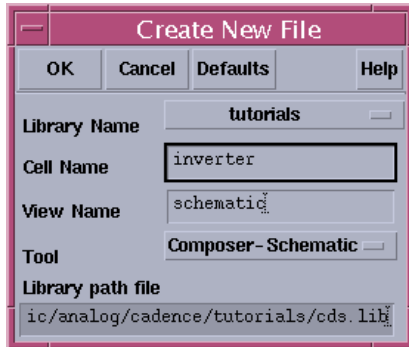

- (a) Enter the Cell Name: *inverter*.
- (b) Click OK.

The Virtuoso® Schematic Editing window will open, and we can now create the CMOS inverter schematic.

2. Before we begin creating the CMOS inverter schematic review the following tips.

Virtuoso® Tips: Virtuoso® uses Hot-Keys. The following table will be useful.

Hot-Key	Action	Hot-Key	Action
i	Add Instance	q	Properties
m	Move	[or]	Zoom in or out
shift + x	Check and Save	p	Add Pin(s)
ctrl + e	Ascend from Symbol	shift + e	Descend into Symbol
w	Add Wire	f	Fit to Screen
c	Copy		

Library Manager Tips: Only two libraries are of interest:

- 1) cmosp18 (contains MOSFETs)
- 2) analogLib (contains res, cap, vdd, vss, vdc, gnd, vpulse).

3. First add an n-channel MOSFET to the schematic in Virtuoso®:

- (a) In Virtuoso® press “i” to open the Add Instance window.

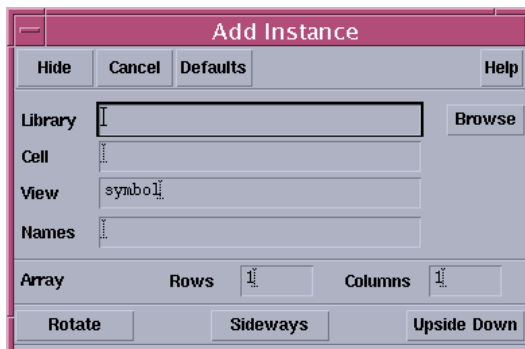

(b) Click the **Browse** button to open the Library Browser.

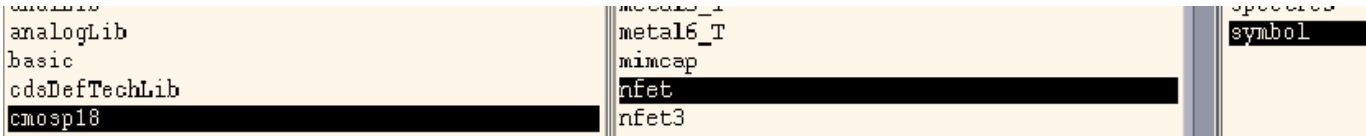

(c) Select the **cmosp18** library. A list of cells appears to the right.

(d) Select the **nfet** cell. A list of views appears to the right.

(e) Choose the **symbol** view.

(f) Go back to the Virtuoso® window, and place the n-channel MOSFET using your mouse.

Follow a similar procedure to create the *inverter* schematic shown below:

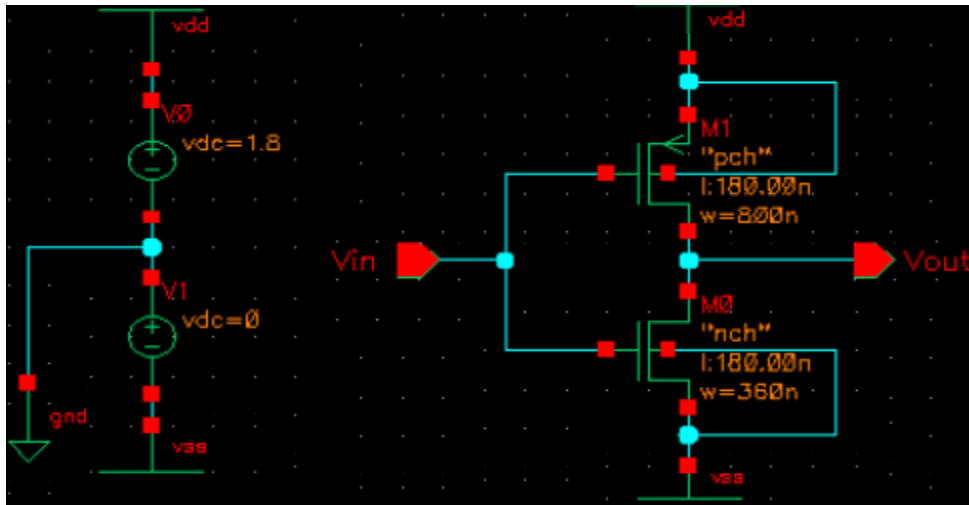

NB: (a) To change the voltage of vdc and the length and width of the MOSFETs, click on the symbol and press “q”.

(b) The red elements that are labelled Vin and Vout are pins. To add a pin press “p”, enter the pin name (Vin or Vout), click Hide, then place the pin using your mouse.

4. Check and save (shift + x) the *inverter* schematic.

5. Create a symbol from the schematic. In Virtuoso®: **Design > Create Cellview > From Cellview**.

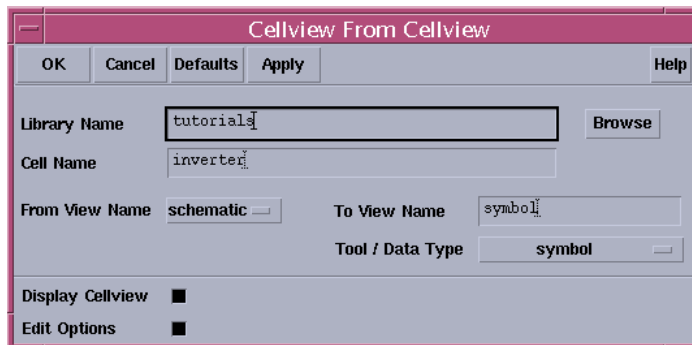

(a) Enter the Cell Name: *inverter*.

(b) Click OK.

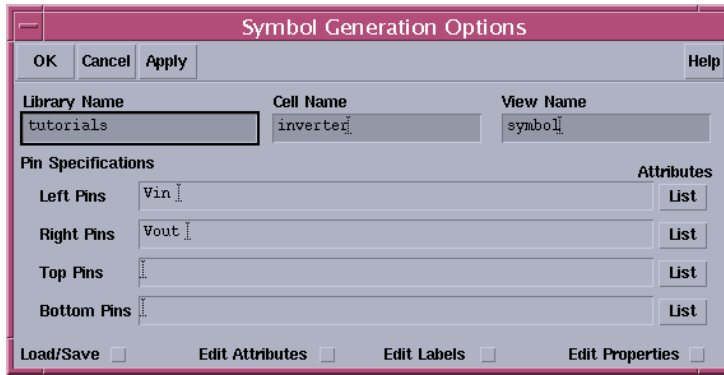

(c) Click OK.

The symbol appears in a new Virtuoso® window as shown below.



(d) Click save  and close the *inverter* symbol Virtuoso® window.

Sanity Check: If you open Library Manager, and look in the *tutorials* library, you will find that the *inverter* cell contains a both *schematic* and a *symbol*.

So far so good!

6. Now we will create a new schematic that contains our *inverter* symbol:

In Library Manager: **File > New > Cell View:**

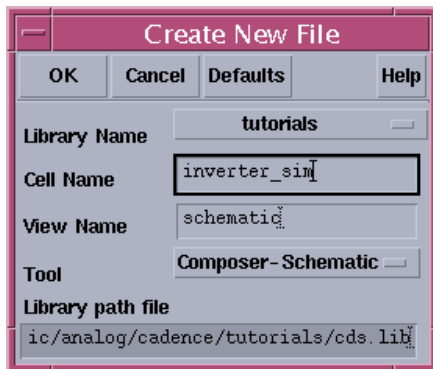

(a) Enter the Cell Name: *inverter_sim* (double check that the Library Name is *tutorials*).

(b) Click OK.

7. Create the *inverter_sim* schematic as shown below:

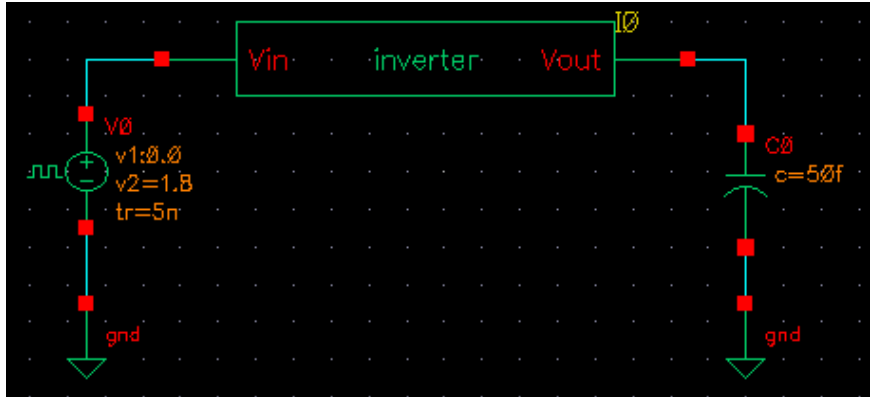

NB: (a) The symbol with the square wave beside it is the *vpulse* symbol (from the analogLib library). Change the properties of the *vpulse* symbol by clicking on its symbol and pressing “q”:

Voltage 1: 0
 Voltage 2: 1.8
 Rise Time: 5n
 Period: 30n

(b) Change the value of the capacitor to 50f by clicking on its symbol and pressing “q”.

8. Check and save (shift + x) the *inverter_sim* schematic.

We now simulate the *inverter_sim* schematic.

SIMULATION

1. Open Analog Design Environment from Virtuoso®: **Tools > Analog Environment**.

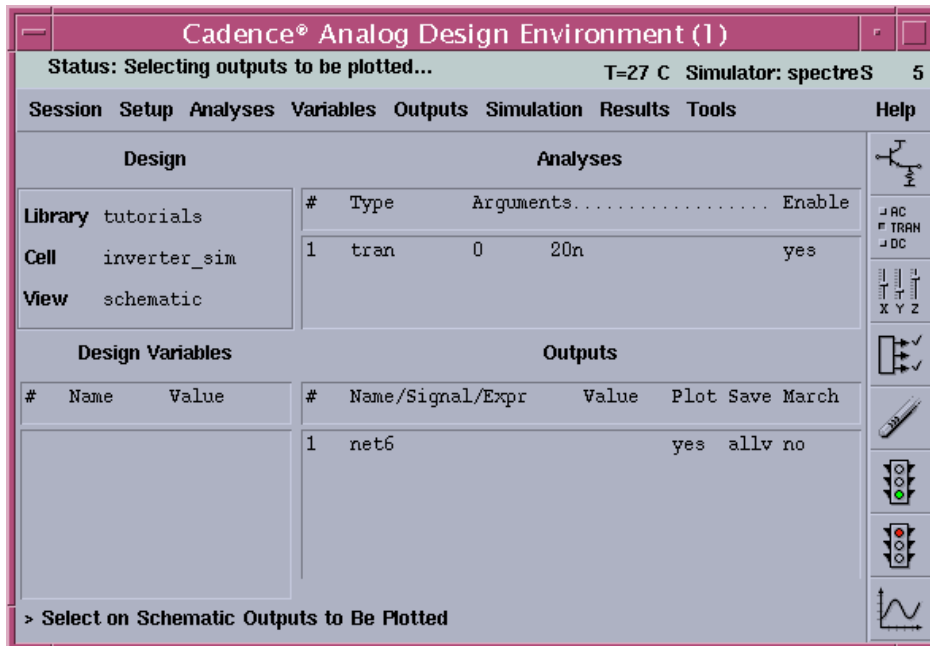

2. Setup the Analog Design Environment:

Setup > Simulator/Directory/Host.

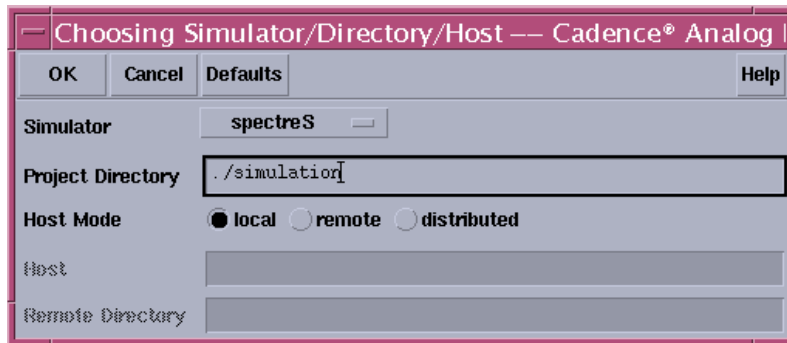

- (a) Choose **spectre** (not spectreS, the figure above is incorrect) from the **Simulator** dropdown list.
(b) Click OK.

Setup > Models Libraries...

- (a) Set the path to:
/CMC/kits/cmosp18/models/spectre/icfspectre.init
(b) Click Add, then Click OK.

3. Perform a transient analysis. In Analog Design Environment:

Analysis > Choose.

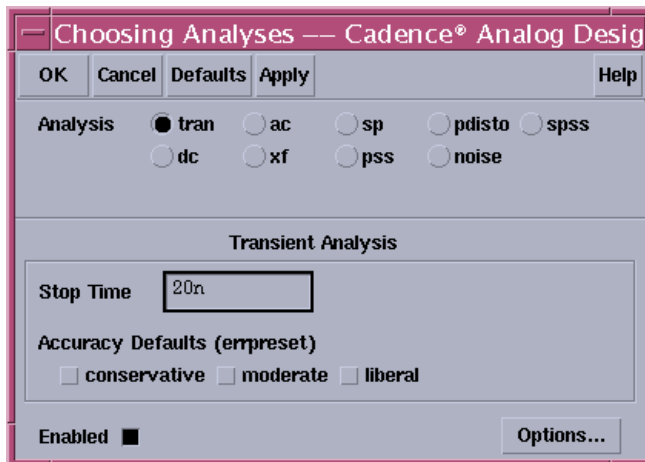

- (a) Select **tran** (transient analysis).
(b) Enter the **Stop Time**: 100n. (not 20ns, the figure above is incorrect) This is the simulation duration.
(b) Click OK.

Outputs > To be plotted > Select On Schematic. To plot the *inverter* input and output, in the *inverter_sim* schematic:

- (a) first click the blue wire at the *inverter*'s input.
(b) then click the blue wire at the *inverter*'s output.
(Be careful where you click.)

Session > Save State...

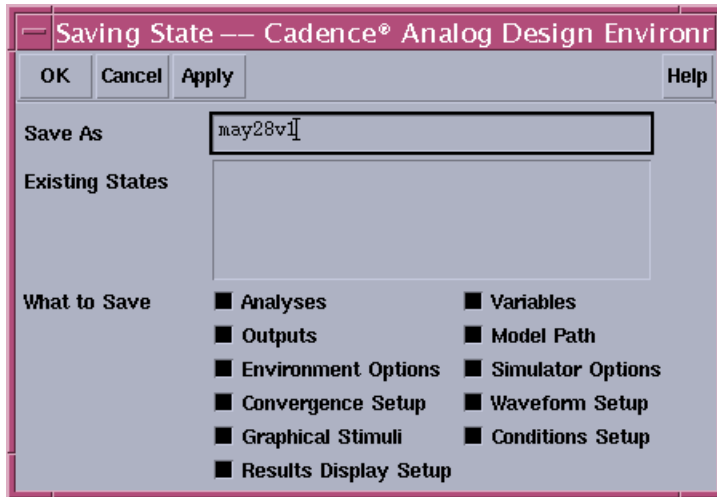

(a) In the Save As textbox enter the date followed by a version number as shown above.

Simulation > Run.

In a moment the Waveform Window will open as shown below. Note that the *inverter* has inverted the input square pulse.

